

## DESIGN AND IMPLEMENTATION OF PV INTEGRATION INTO UTILITY GRID USING BUILDING ENERGY MANAGEMENT SYSTEM

Rehnuma Afrin<sup>1,\*</sup> and M. Tazul Islam<sup>2</sup>

<sup>1</sup>Institute of Energy Technology, CUET, Chittagong - 4349, Bangladesh

<sup>2</sup>Department of Mechanical Engineering, CUET, Chittagong - 4349, Bangladesh

<sup>1,\*</sup>rehnuma.eee.ctg@gmail.com, <sup>2</sup>tazul2003@yahoo.com

**Abstract-** *Solar Photovoltaic Grid Integration Systems is the key to achieve high penetration including improved and reliable photovoltaic inverter/controllers while developing interfaces for advanced grid integration. Encouraged by the availability of solar radiation in Bangladesh (5KWh/m<sup>2</sup>), we are designing a grid integrated solar system by implementing Building Energy Management System (BEMS). A 200W-p Solar Home System has been designed dividing the loads into different categories with microcontroller and sensors interfaced with GSM technology including security system. The result was, BEMS is 16.83% and solar system is 44.22% energy efficient. Combining both systems, efficiency increased to 59.74% and with net-metering becomes 64.68%. The objective of this paper is to present a load optimization system, which will help to reduce electricity usage and to make the electricity more available using cost-effective environment friendly resource. Optimization of energy balance will improve the economics of the photovoltaic system by providing value added to the consumers.*

**Keywords:** PV grid Integration, Energy Management System (EMS), Arduino, GSM technology, Data Acquisition

### 1. INTRODUCTION

The conventional sources of energy are becoming expensive and are limited in number. Bangladesh receives an average daily solar radiation in the range of 4-5 kWh/m<sup>2</sup>. Power Division of Bangladesh has initiated a program to generate 500MW of solar-based electricity [1]. Because of financial incentives and advanced research in PV technologies, the cost of PV panels has dropped from \$50/watt in 1975 to less than one dollar per at present [2]. A dedicated policy, Renewable Energy Policy of Bangladesh (SREDA), has been in force since 2009, which envisions having 5% power from renewable energy sources by 2015 and 10% by 2020[1]. Bangladesh already receives 500MW of electricity from the West Bengal and there will be an addition of more 600MW from Tripura, India whereas there is a very good chance to produce energy by solar system.

The current installed capacity of the electricity generation is 11447MW/day and the generation capacity is 10345MW/day. Our daily demand is 9.79GW or 9790MW but the power production on March 2015 is 6914MW/day. Still 2876MW demand of energy cannot be fulfilled despite of having installed capacity of 11447MW. The reasons behind the gap between the installed capacity and the generation capacity can be the rising cost and unavailability of fossil fuels, lack of experienced workers, lack of computerized distribution system [3]. The total solar energy reaching Bangladesh

is  $180 \times 10^9$  MWhr/year which is 105 times the energy generated as electricity [4].

Energy Management System (EMS) will hereby help to remotely control the loads which will decrease the total electricity usage. In addition the loads can be managed according the user requirements. The high power drawing loads can be used in off-peak hours as well as sensors can be used for the security purposes. It can be done with a microcontroller based system and for the experiment of the proposed system Arduino has been used.

Arduino is an open-source computer hardware and software company, project and user community that designs and manufactures microcontroller-based kits for building digital devices and interactive objects that can sense and control the physical world. The first Arduino was introduced in 2005, aiming to provide an inexpensive and easy way for novices and professionals to create devices that interact with their environment using sensors and . Arduino microcontrollers are basically used for the Smart Projects using various 8-bit Atmel microprocessor 32-bit Atmel ARM processors. These systems provide sets of digital and analog I/O pins that can be interfaced to various expansion boards ("shields") and other circuits [5].

The boards feature serial communications interfaces, including USB on some models, for loading programs from personal computers. For programming the microcontrollers, the Arduino platform provides an integrated development environment (IDE) based on

the Processing project, which includes support for C and C++ programming languages[5].

By integrating Arduino with relay for home energy management microcontroller can manage the lamp, fan and air-conditioner etc. PIR motion sensors, temperature sensors can be used to control the household loads. For example PIR motion sensor can be used to turn on/off the lamp and temperature sensor can be used to turn on/off the air-conditioner automatically.

## 2. OVERVIEW OF THE SYSTEM

The proposed system can be divided into two major parts- i) PV Grid Integration, ii) Energy Management System. The block diagram of the whole system is represented in the Figure below.

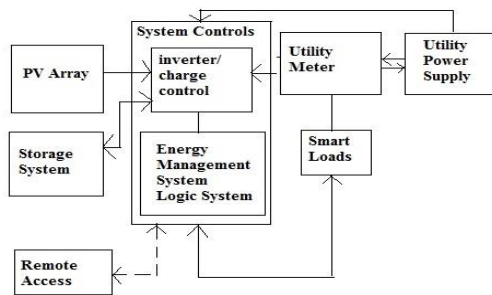

Fig.1: Block Diagram of the PV grid Integration with BEMS

### 2.1 PV Grid Integration Systems

Highly integrated, innovative, advanced inverters, new controllers and methodologies for residential and commercial solar energy applications are goals of the Solar Energy Grid Integration System(SEGIS). Advanced integrated inverters/controllers are incorporating energy management functionality, intelligent electrical grid-related features and a multiplicity of communication technologies. The work focuses on grid-integrated systems, but advanced stand-alone energy management controls can be used. Portals for energy flow and two-way communications enable PV system interactive operations with evolving, available, smarter metering infrastructures [6].

SHS requires PV arrays, controller, inverter, kWh meter, storage system to implement the system. The storage system should be connected with the utility supply so that the access power can be transferred thus reduces the power drainage.

The major difference between the off-grid and on-grid system is that the storage system in the off-grid Solar Home System (SHS) drains the excess power stored in the batteries, whereas in grid-tied system the excess power can be transferred to the utility or can be used by other consumers.

### 2.2 Energy Management System

The Energy Management System is essential to control the energy consumption. This is a computer-based system that helps to manage, control and monitor the loads and technical services, for example HVAC and lighting. Energy Management System helps to control the energy usage by reducing standby power

consumption, load automation thus improves buildings' energy performance.

Usually to maximize the period of independent operation, essential and non-essential loads are separated at the load center by the BMS (Building Management System), and only essential loads are supported with energy from storage. To accommodate and optimize management of these resources, it is expected that the advanced distribution system will be a "Smart Grid" [2].

## 3. DESIGN LAYOUT OF A PV GRID INTEGRATION SYSTEM

### 3.1 Fabrication

A 200W-p SHS (Solar Home System) has been designed by implementing Energy Management System for the household loads. Data has been taken from the utility meter to check the efficiency of the system. A theoretical layout is shown in the following Figure.

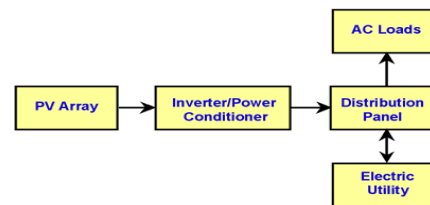

Fig.2: Theoretical Block Diagram of PV Grid Integration System

### 3.2 Data Acquisition

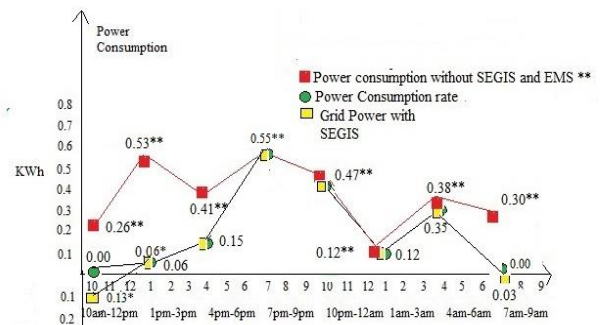

Fig.3: Graphical Representation of the efficiency of PV grid integration system

From the Figure we can see that, without Solar PV integration the power consumption is 3.03KWh/day with load of 3015W-p. With PV integration it is 1.69KWh. If Net-Metering is available 0.16KWh can be sold to utility and makes the system 49.5% Efficient

## 4. ARDUINO FOR ENERGY MANAGEMENT SYSTEM

### 4.1 Basic BEMS Concept

A Building Energy Management System (BEMS) is a computer-based control system installed in buildings that controls and monitors the building's equipments and appliances such as lighting, power systems, fire systems, and security systems. A BMS consists of software and hardware; the software program, usually

configured in a hierarchical manner. Its inputs, such as temperature sensors and outputs, such as on/off signals are connected. In addition a modem is also connected to the system to allow remote access. The level of control via the BMS is dependent upon the information received from its sensors and the way in which its programmes tell it to respond to that information [7].

#### 4.2 Experimental Model

The components used for the project to establish a BEMS are -Arduino UNO R3, GSM sim900 and PIR sensor etc. Circuit layout is shown in Fig.4. The entire system includes automated load control using sensors and predefined time slots for different appliances, sensor based security, and remote controlling device to manage the loads remotely. This computerized system will help to save energy or in other words we can say will help to reduce the electricity bill by reducing the energy usage. The circuit diagram of the fabricated EMS is given in the Figure below.

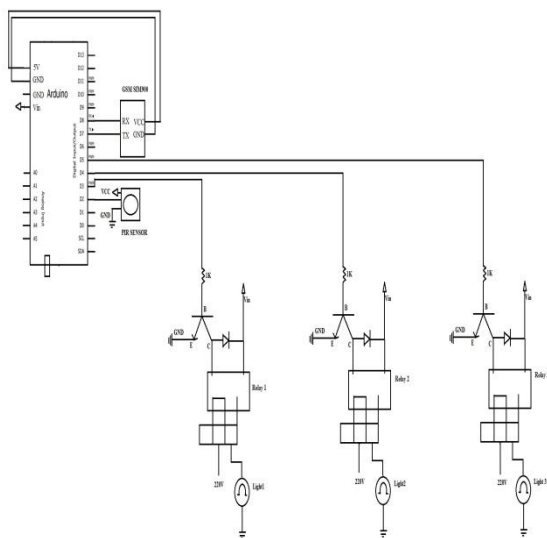

Fig.4: Circuit Diagram for the Experimental EMS

#### 4.3 Coding of the different operations

For Time manageable loads:

```
digitalWrite(light1,HIGH);
delay(10000);
digitalWrite(light1,LOW);
digitalWrite(light2,HIGH);
delay(10000);
digitalWrite(light2,LOW);
digitalWrite(light3,HIGH);
delay(10000);
digitalWrite(light3,LOW);
}
```

For Load automation and Security System:

```
if(digitalRead(pir))
{
state = !state;
digitalWrite(light1,state);
Serial.println("Human Detected");
}
```

```
if(state == 1)
{
generate_sms();
}
delay(5000);
}
count = 0;
text = " ";
}
void generate_sms()
{
gsmModem.print("AT+CMGF=1\r"); // AT command
to set SMS Format to text mode
delay(100);
gsmModem.println("AT + CMGS =
'+880177xxxxxxx\r'");
delay(100);
gsmModem.println("Human Detected"); // message to
send
delay(100);
gsmModem.println((char)26);
delay(100);
gsmModem.println();
delay(5000);
}
For Remote controlled device:
if(text.substring(text.indexOf("A0"),text.indexOf("A0")
+2)=="A0")
{
digitalWrite(light1,LOW);
}
else
if(text.substring(text.indexOf("A1"),text.indexOf("A1")
+2)=="A1")
{
digitalWrite(light1,HIGH);
}
}
```

#### 4.4 Data Acquisition

Loads were divided into three categories- Unshed-able, Time Manageable and storage capable. Unshed able loads should be always turned on i.e refrigerator, some communication devices etc. Time Manageable loads can be washing machine, water pump etc and storage capable loads are- cellular phone, laptop etc.

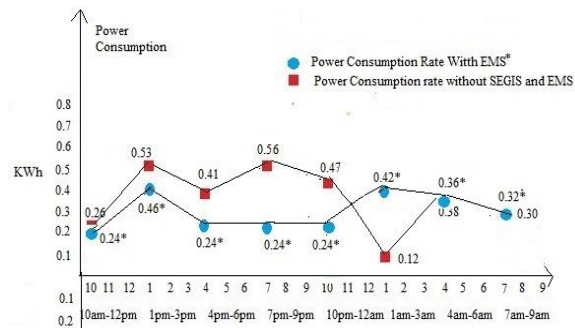

Fig.5: Graphical Representation of Power Consumption Rate with and without EMS

After the load automation and management system implementation the result from the Figure. is- without BEMS consumption of 3015Wp load is 3.03KWh/day

and with BEMS consumption rate is 2.52KWh which is 16.83% efficient. The difference in power consumption is clearly noticeable from the Time Vs KWh consumption graph in the Figure. According to U.S green building Council, Buckman Laboratories Int. and a pilot project of Clemson University research work states that, BEMS can save 15-25% power consumption [8-10].

### 5. RESULTS AND DISCUSSION

Implementation of BEMS with PV integration has reduced the energy consumption from utility by 60% whereas without BEMS it was 44%.

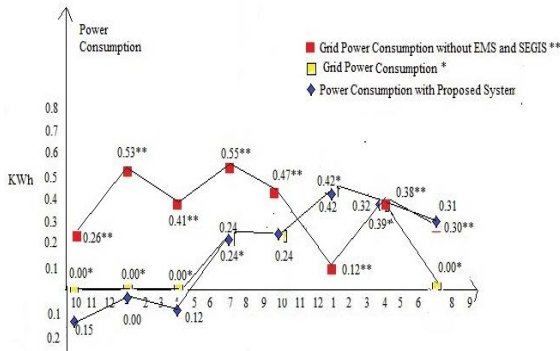

Fig.6: Graphical Representation of Power Consumption by Current System and PV Integration with BEMS

The above Figure represents the differences between the power consumption rate of peak-hour loads and off-peak hour loads of the current system and the proposed system. In solar PV integrated with Energy Management System, loads during peak hour (5pm-11pm) are remarkably lower than the regular system. This will help the government to fulfill the industrial electricity demand. In addition, reduced standby power consumption and load automation helped to save energy. If we take the summation of the KWh rating in both cases the KWh consumed in current system will be 3.03KWh and KWh consumed in proposed system is 1.22KWh. Thus, consumes 59.74% less energy from utility.

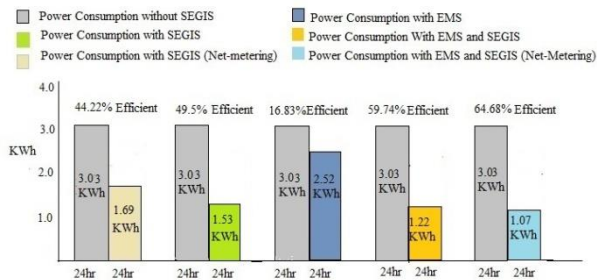

Fig.7: Comparison of % Efficiency with Current System and PV integration with BEMS

From the Figure we can compare all the possible results by taking in consideration different kind of

operations with BEMS and PV integration. Six different considerations have been represented with comparison in %efficiency. The project we presented is 64.68% efficient.

### 6. COST ANALYSIS

Earlier the consumer used to pay for 3.03 KWh per day. Cost per day = (3.03 x 3.3) BDT = 9.99 BDT or 10 BDT (approximate value) for 3015W-p loads per day. Cost per year = 10 BDT x 365 = 3650 BDT After PV integration, Power consumed from utility = 1.69 KWh.

Cost per day = 5.78BDT. Cost per year = 5.78BDT x 365 = 2109.7BDT. Bill reduced per year = (3650 – 2109.7) BDT = 1540.3BDT. If the system is net-metered or if the excess power can be sold to any other consumers, per year the cash to be paid is = (0.16 x 3.3 x 365) BDT = 192.72BDT. As a result, bill reduced per year = 1540.3BDT + 192.72BDT = 1733.02BDT = \$21.66 (approximate value).

HOMER works on grid or off. HOMER shows how to cost-effectively combine renewable systems with grid power for maximum reliability [11]. After inserting the information about the price estimation for 25 years of lifetime estimated as the Fig.8.

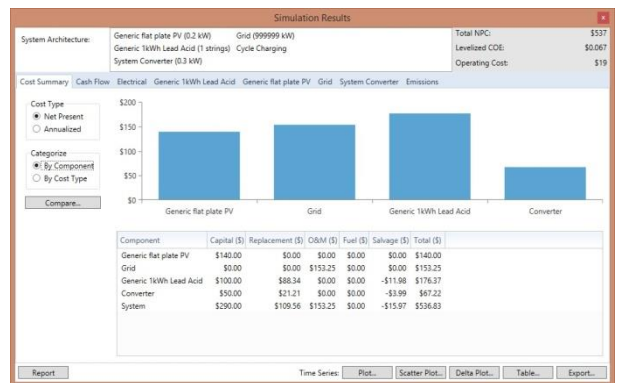

Fig.8: Cost analysis of 200W-p SHS with HOMER

The Figure shows the cost of PV integration of 200W-p at residential building is \$536.83 which equals to = 42946.4BDT for 25years of lifespan.

Per year installation cost = 1717.86BDT, which is less than the cost 1733.02BDT, the amount of bill reduced per year. Thus, the consumer will be benefited. In EMS, the most expensive equipment is GSM module. Installation cost per year for EMS is 206.4BDT. Per year electricity bill = 3.03 x 3.3BDT x 365= 3649.635BDT. With EMS = 2.52 x 3.3BDT x 365= 3035.34BDT. Electricity bill reduced annually = 3649.635BDT– 3035.34BDT= 614.295BDT.

Cost saved/year = 614.295BDT – 206.4BDT= 407.895BDT in case of our experimental design. For extended loads we can implement the same system with more PIR sensor and more relay module. So the total cost of the system becomes 6260BDT while taking in consideration a residence.

Minimum Lifespan =  $6260/15 = 417.33$ BDT/year  
 Monthly bill at my home is 1200BDT on average 15 % reduction becomes = 180 BDT /month. Per year saved =  $(180 \times 12)$  BDT = 2160 BDT. Amount saved annually =  $(2160-417.33)$  BDT = 1742.67BDT.

Therefore, by considering minimum lifespan with minimum efficiency 12% cost can be saved annually after deducting the installation cost if EMS is implemented in our residence.

### 7. CONCLUSION

We can conclude from our experiment that, Solar PV installation reduced the power consumption from utility by 44.22% and if the excess power can be sold to other consumers efficiency becomes 49.5%. BEMS reduced the energy consumption by 16.83%. If Solar PV System is integrated with BEMS the system becomes 64.68% efficient.

Near about 300MW of power can easily be generated from solar energy to feed the national grid if solar PV systems are installed on rooftops of 20,000 multistoried buildings in capital city, Dhaka [12]. Thus, if we can implement PV System all around the country approximately 1200MW-1500MW energy can be produced by using natural resource which has no negative impact on the environment with no need of large empty lands.

The objective of this project was to propose a system which will reduce the electricity drainage while not in use and to make an efficient system without being dependent on the conventional sources. The proposed system will be highly beneficial to overcome the electricity scarcity in Bangladesh.

### 8. REFERENCES

[1] Mohammad Alauddin, The Daily Star, <http://www.thedailystar.net/development-of-renewable-energy-in-bangladesh-49670>, accessed on 11-11-2014  
 [2] Sangita Sharma, David W. Galipeau, Optimization of Residential Grid-Tied PV Systems without Net-metering Using Load Management, IEEE ICSET 2012, Nepal, accessed on 15-02-2015  
 [3] <http://www.bpdb.gov.bd/bpdb/>, accessed 20-4-15  
 [4] Nazmul Hasan Shiblee, Solar Energy in Urban Bangladesh: An untrapped potential, ChE Thoughts 2 (1), 8-12, 2011, accessed on 19-4-15  
 [5] <https://www.arduino.cc/>, accessed on 15-5-2015  
 [6] Ward bower, Scott kuzmaul, Sigifredo Gonzales, Abbas Akhil, Solar Energy Grid Integration System (SEGIS), Proactive Intelligent Advances for Photovoltaic Systems, Sandia National Laboratories, NM87185, USA, Materials, Devices and Energy Technology, Photovoltaic and Grid Integration, Distributed Energy Resources, accessed on 15-02-2015  
 [7] Juzer Zoher hossain, Ahmed kotb, <http://www.bayt.com/en/specialties/q/43221/what-is-the-building-managment-system-bmsand-for-what-we-can-use-it/>, accessed on 25-4-15  
 [8] Clemson University Project Profile, [http://www.johnsoncontrols.com/content/dam/WWW/jci/be/case\\_studies/6748\\_Clemson\\_univ\\_project\\_profile\\_1owres.pdf](http://www.johnsoncontrols.com/content/dam/WWW/jci/be/case_studies/6748_Clemson_univ_project_profile_1owres.pdf), accessed on 14-5-2015

[9] Wendell Rose, Buckman Laboratories Int. Inc, [http://www.johnsoncontrols.com/content/dam/WWW/jci/be/case\\_studies/Buckman\\_Labs\\_v1.pdf](http://www.johnsoncontrols.com/content/dam/WWW/jci/be/case_studies/Buckman_Labs_v1.pdf), accessed on 14-5-2015

[10] Chris Wheeler, U.S Green Building Council, [http://www.johnsoncontrols.com/content/dam/WWW/jci/be/case\\_studies/video/ColonyParkCaseletFinal082010.pdf](http://www.johnsoncontrols.com/content/dam/WWW/jci/be/case_studies/video/ColonyParkCaseletFinal082010.pdf), accessed on 14-5-2015

[11] <http://www.homerenergy.com/index.html>, accessed on 21-8-15

[12] Taskin Jamal1, Weerakorn Ongsakul2, Molla Shahadat Hossain Lipu3, Mohammad Shafquatul Islam1, An Approach to Integrate Geographic Information Systems to the proposed Smart Grid for Dhaka, Bangladesh, IJSET 2014, Feb 1<sup>st</sup> 2014, accessed on 15-8-15

### 9. NOMENCLATURE

Symbol	Meaning	Unit
<i>PV</i>	Photovoltaic	Dimensio
<i>W-p</i>	Watt-power	n-less
<i>KWh</i>	Kilowatt-hour	W
<i>BDT</i>	Bangladeshi Taka	KW
<i>MW</i>	Megawatt	Dimensio
		n-less
		W